

76

97.6

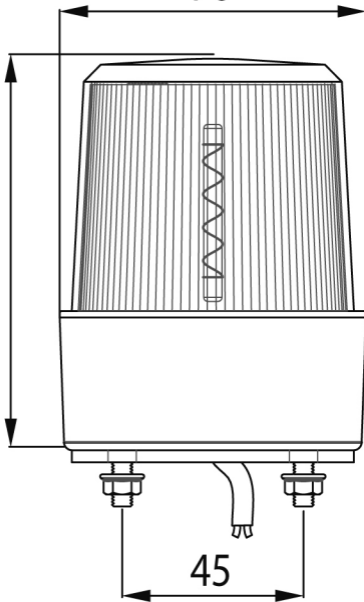

45